

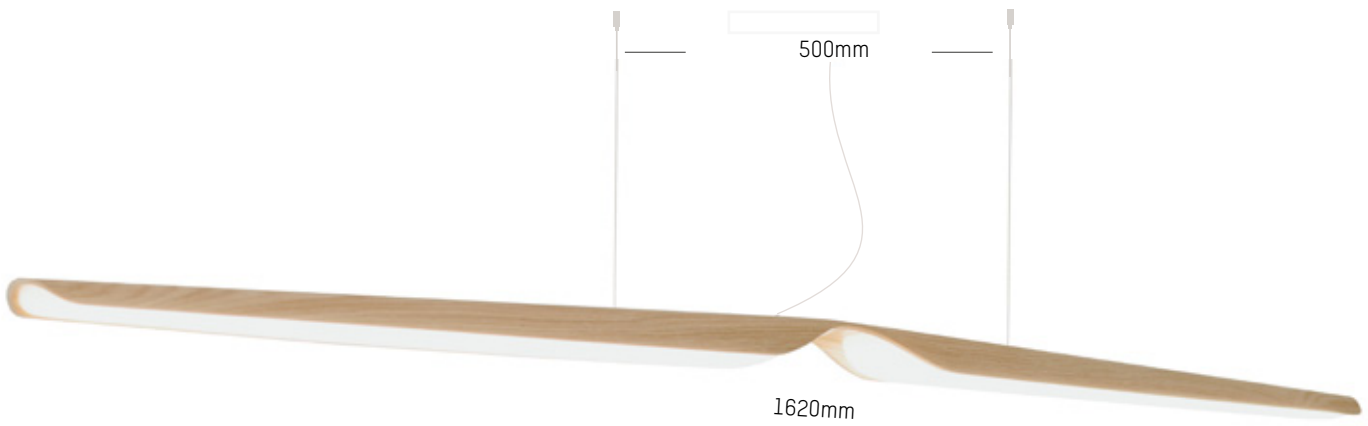

Swan



Available colors and materials



TUNTO **swan**
pendant

 This luminaire contains built-in LED lamps.

 } LED

The lamps cannot be changed in the luminaire.

2800 Kelvin
50 000 h



874/2012

ASSEMBLY INSTRUCTIONS TO CABLE HOLDER

Easy, adjustable ceiling installation.
 The plastic-covered wire is 1,5 mm thick with a maximum length of 5 m.

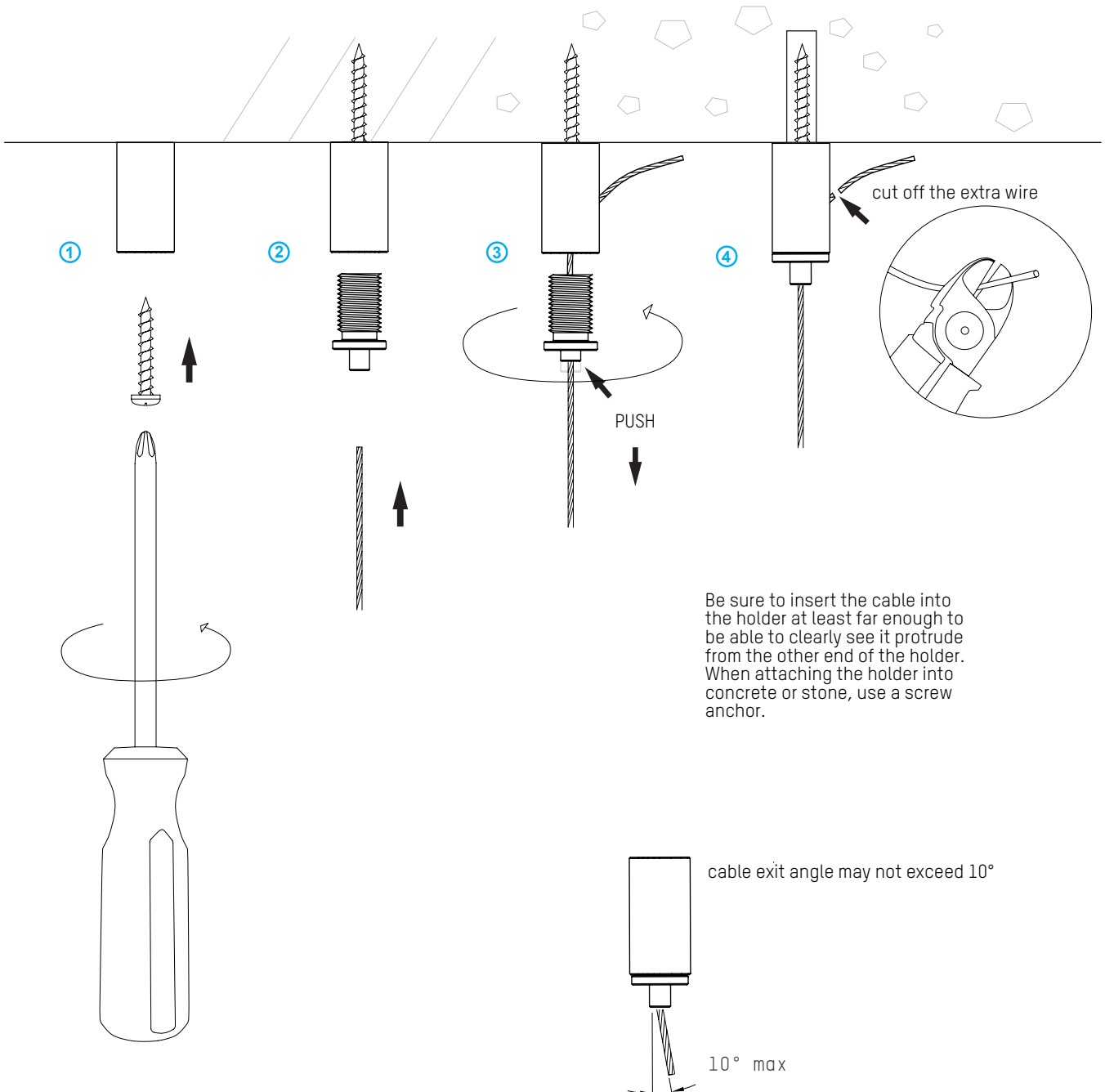

TUNTO DESIGN
 Tekijänkatu 8, FI-04440 Järvenpää, Finland
 Tel. +358 10 421 3000
 mail@tunto.com

**Install in accordance with national and local electrical codes.
All installation works must be performed with professional personnel.**

POWER SUPPLY BOX

White ceiling cup RAL 9016
Standard 220 x 100 x 35mm.

ASSEMBLY

The power supply must be installed at a maximum of 5 m from the lamp into the wall, ceiling or to a specific location.

For more specific instructions see the following driver data sheet.

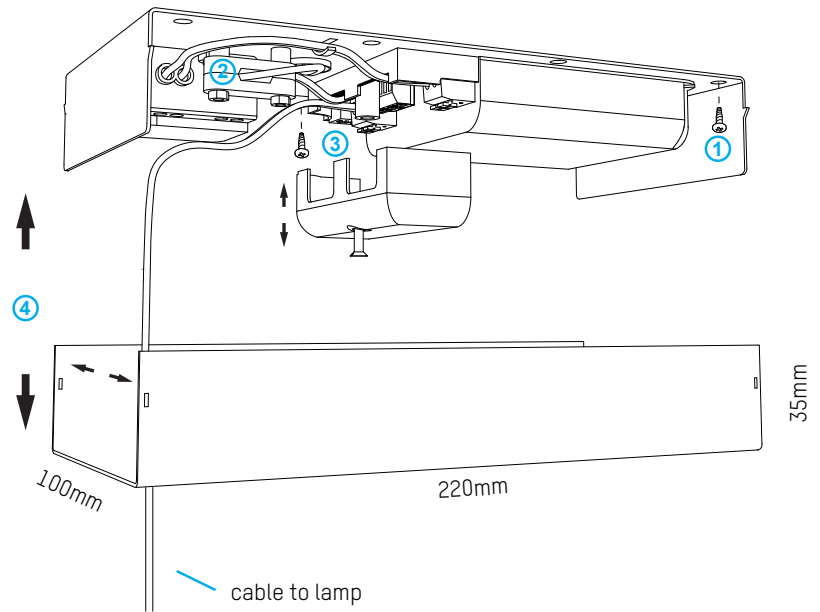

TOP VIEW

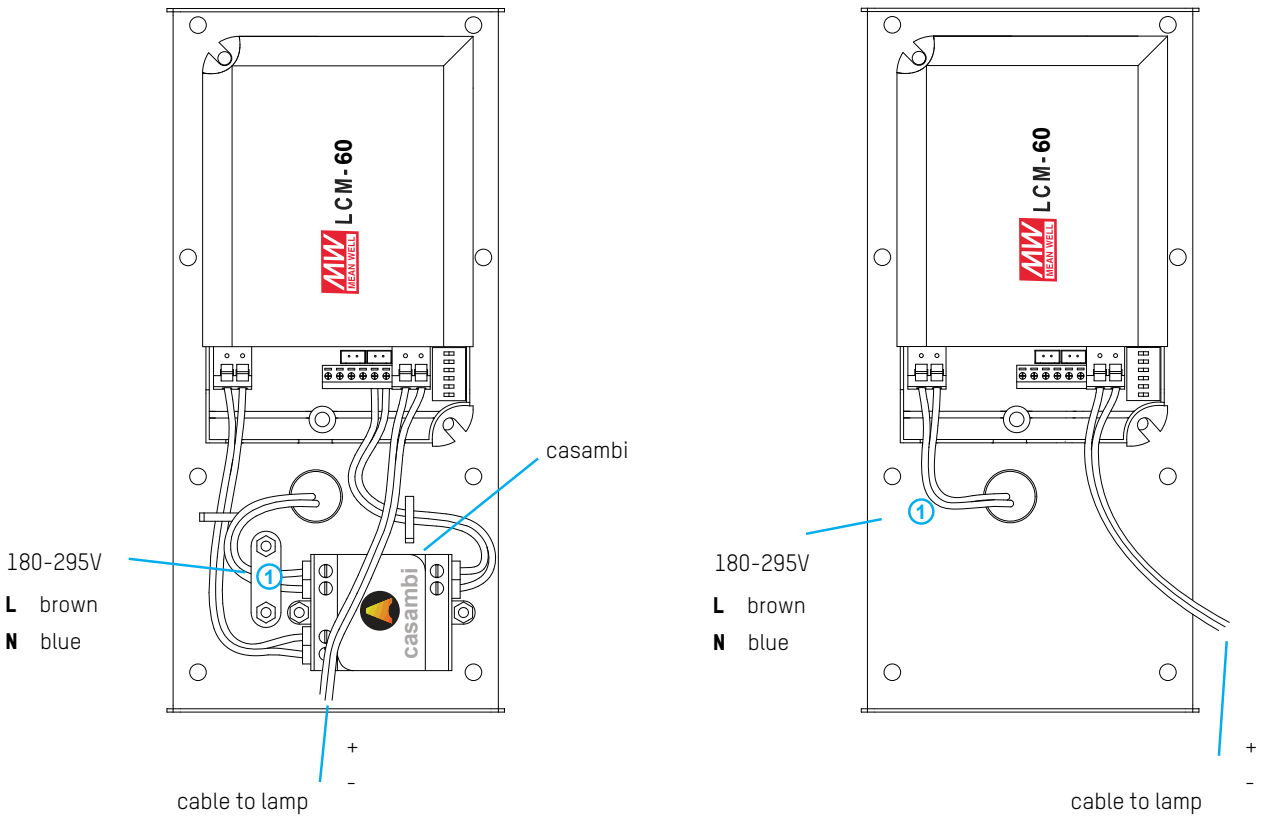

If you cut the lamp cable, the marking for +/- will disappear.
Just try which side works. Choosing a wrong side does not harm the light.

Install in accordance with national and local electrical codes.
All installation works must be performed with professional personnel.

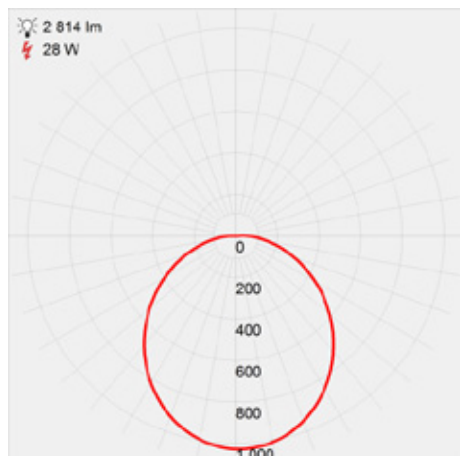

350mA 2814 lm 28W

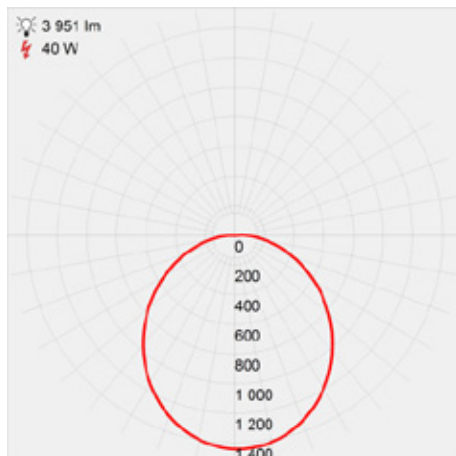

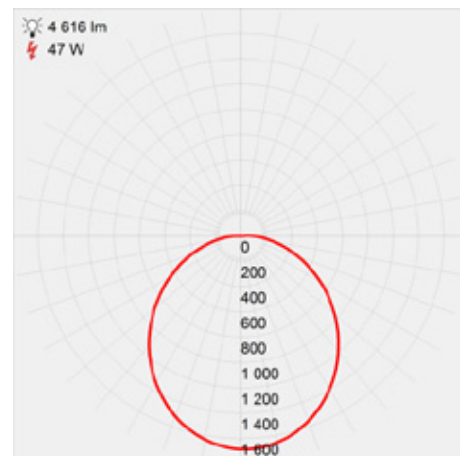

500mA 3951 lm 40W



600mA 4616 lm 47W

Available Drivers

350mA	0-10V/ PWM	LCM-40
	DALI, push dim	LCM-40DA
	CASAMBI Dim	LCM-40CAS 

500/600mA	0-10V/ PWM	LCM-60
	DALI, push dim	LCM-60DA
	CASAMBI Dim	LCM-60CAS 

INDOOR USE ONLY



non-user replaceable light source

Rated Power	28-47 W
Voltage	180-295 V 50/60 Hz
Output	350,500,600 mA
Cord Length	Standard 2m, on request max 5m, transparent
Power Box	White ceiling cup 220x100x35mm RAL 9016 fine efekt

Kelvin	2800K
Lumen	350mA / 2814 lm 500mA / 3951 lm 600mA / 4516 lm
CRI	80 Typ
Package Size	130 x 110 x 1660 mm
Package Weight	5,5 kg
Surface Finish	Lacquer